

SPECIFICATION FOR LCD MODULE

Model No. TM244BFFU6

Prepared by:	Date:
Checked by :	Date:
Verified by :	Date:
Approved by:	Date:

TIANMA MICROELECTRONICS CO., LTD

REVISION RECORD

Date	Ver.	Ref. Page	Revision No.	Revision Item

1 General Specifications:

- 1.1 Display type: STN
- 1.2 Display color*¹:
 - Display color*²: White
 - Background: Blue
- 1.3 Polarizer mode: Transmissive/Negative
- 1.4 Viewing Angle: 12:00
- 1.5 Driving Method: 1/33 Duty 1/6 Bias
- 1.6 Backlight: LED
- 1.7 Controller: S6B0078X01-C0CX
- 1.8 Display Fonts: 5 x 7 dots+Cursor (1 Character)
- 1.9 Data Transfer: 8 Bit Parallel
- 1.10 Operating Temperature: 0----+50°C
 - Storage Temperature: -20----+60°C
- 1.11 Outline Dimensions: Refer to outline drawing on next page
- 1.12 Dot Matrix: 24 Characters X 4 Lines
- 1.13 Dot Size: 0.60X0.65(mm)
- 1.14 Dot Pitch: 0.65X0.70 (mm)
- 1.15 Weight: Approx 100g

*¹ Color tone is slightly changed by temperature and driving voltage.

*² Color tone will be changed by backlight.

2 Outline Drawing

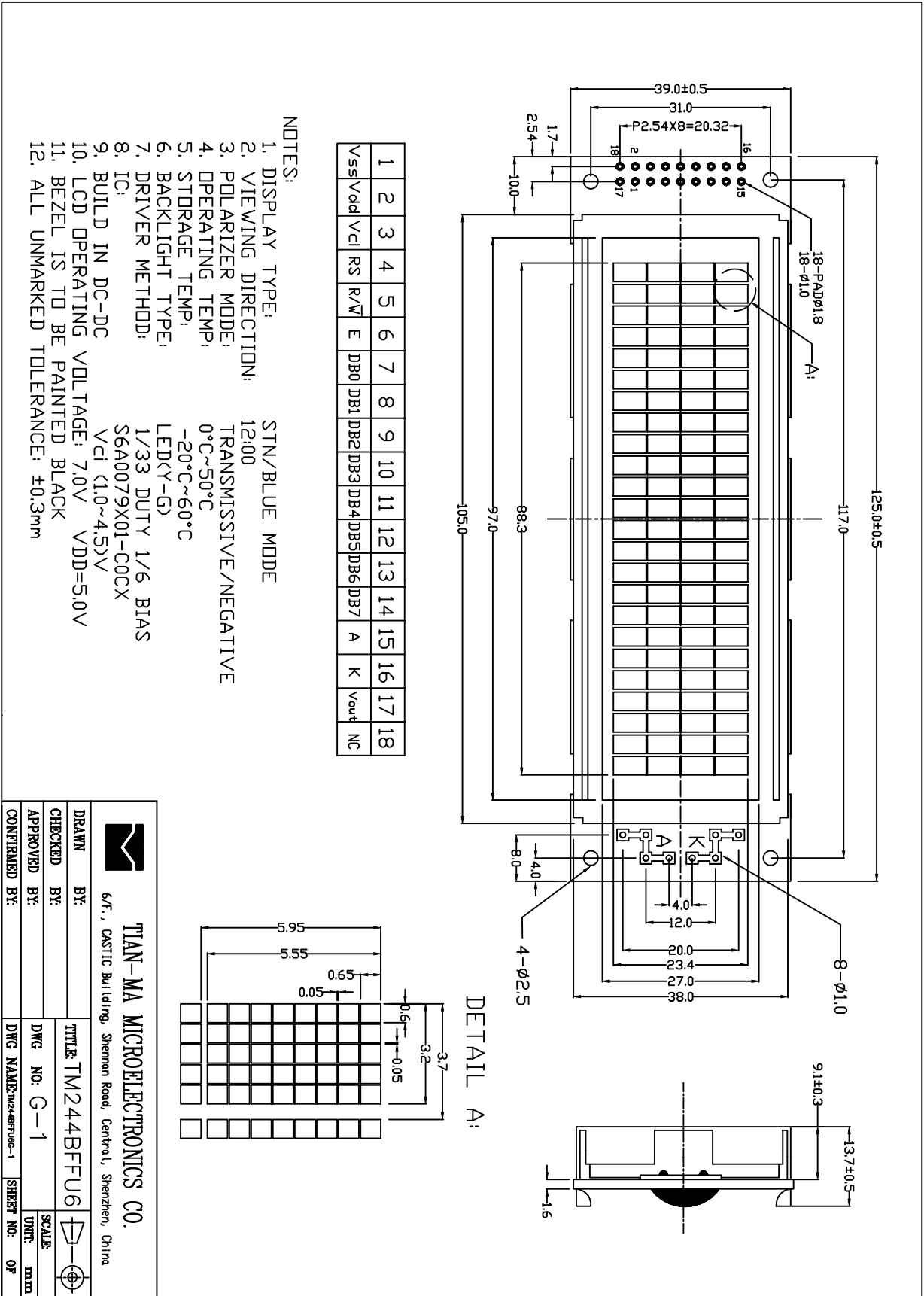

3 LCD Module Part Numbering System

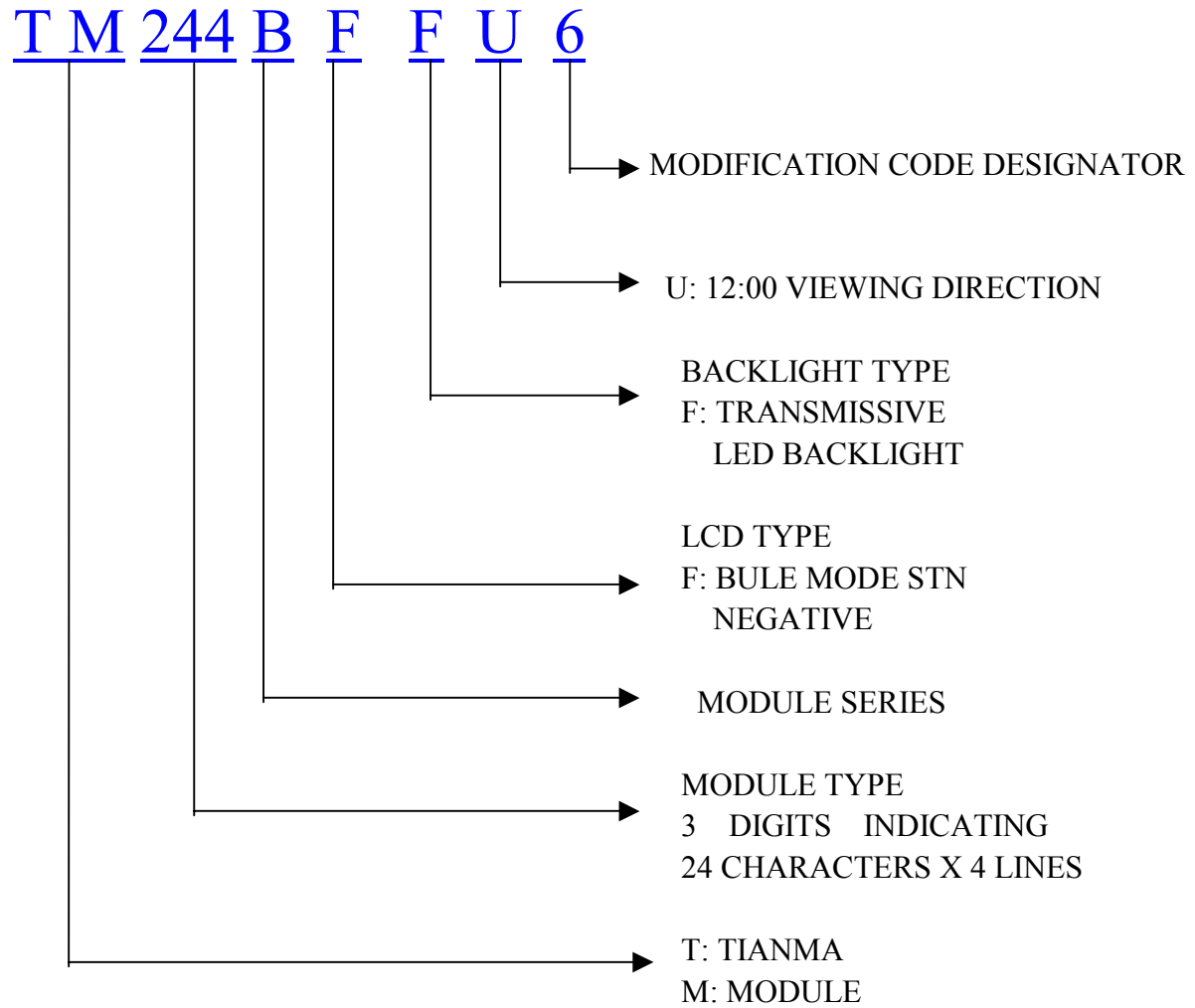

4 Circuit Block Diagram

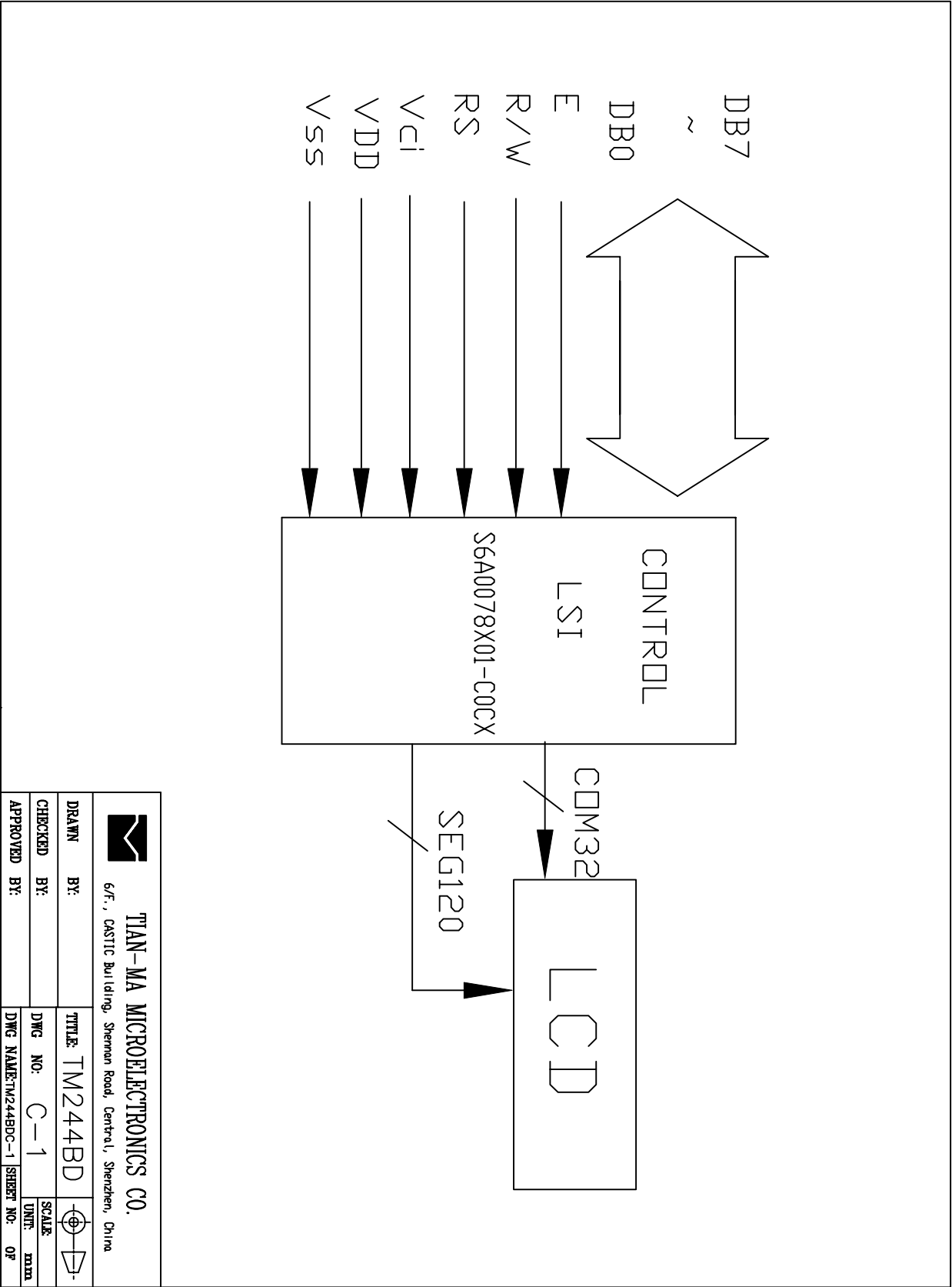

5 Absolute Maximum Ratings

Item	Symbol	Min.	Max.	Unit	Remark
Power Supply Voltage	$V_{DD}-V_{SS}$	-0.3	6.0	V	
LCD Driving Voltage	V_{LCD}	-0.3	25.0		
Operating Temperature Range	T_{OP}	0	+50	°C	No Condensation
Storage Temperature Range	T_{ST}	-20	+60		

6 Electrical Specifications and Instruction Code

6.1 Electrical characteristics

Item	Symbol	Min.	Typ.	Max.	Unit
Supply Voltage (Logic)	$V_{DD}-V_{SS}$	4.5	5.0	5.5	V
Supply Voltage (LCD Drive)	V_{LCD}	-	7.0	-	V
Input Signal Voltage	High V_{IH} ($V_{DD}=5.0$)	$0.8V_{DD}$	-	$V_{DD}+0.3$	V
	Low V_{IL} ($V_{DD}=5.0$)	0	-	$0.2 V_{DD}$	V
Supply current (Logic)	I_{DD} ($V_{DD}-V_{SS}=5.0V$)	-	1.4	-	mA
Supply current (LCD Drive)	I_{EE}	-	0.85	-	mA
Supply current (LED)	I_{LED}			410	mA

6.2 Interface Signals

Pin No.	Symbol	Level	Description
1	Vss	0V	Ground
2	Vdd	5.0V	Power supply voltage for logic and LCD(+)
3	Vci	2.0~4.5V	The voltage converter to generate LCD drive voltage
4	RS	H/L	Selects registers
5	R/W	H/L	Read/Write Signal
6	E	H/L	Chip enable Signal
7	DB0	H/L	Data bit0
8	DB1	H/L	Data bit1
9	DB2	H/L	Data bit2
10	DB3	H/L	Data bit3
11	DB4	H/L	Data bit4
12	DB5	H/L	Data bit5
13	DB6	H/L	Data bit6
14	DB7	H/L	Data bit7
15	A	4.2V	Backlight Power Supply(+)
16	K	0V	Backlight Power Supply(-)
17	Vout	-2.0V	Two times converter output
18	NC	-	No connection

6.3 Interface Timing Chart

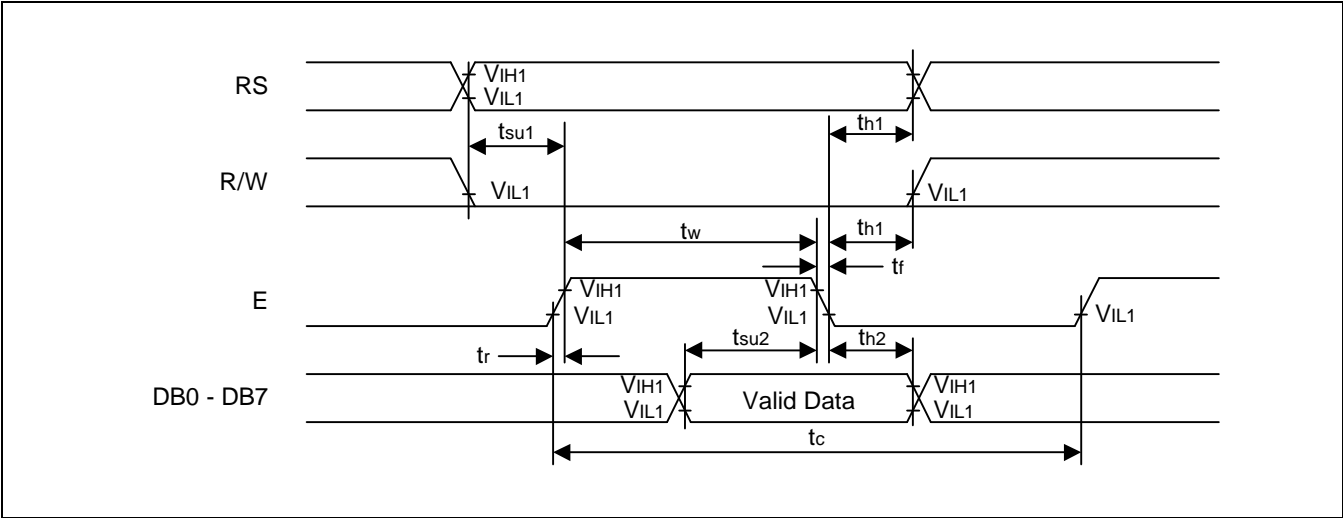

Write Mode

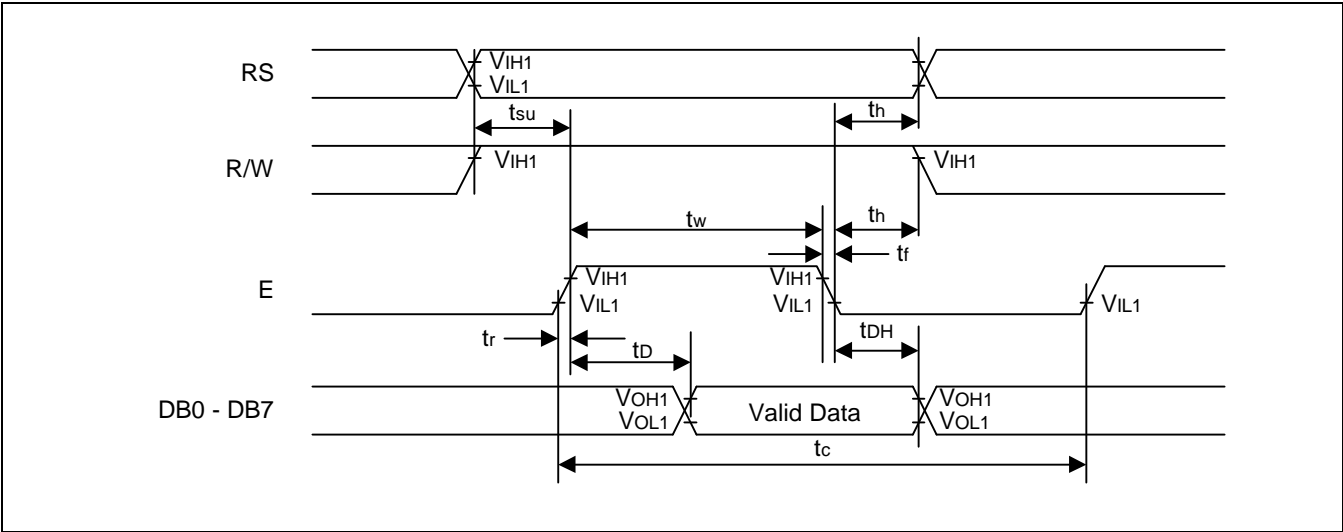

Read Mode

6.4 Instruction Code

INSTRUCTION DESCRIPTION 1 (IE = "HIGH")

Instruction Set 1

Instruction	RE	Instruction Code										Description	Execution Time (fosc = 270kHz)	
		RS	R/W	DB7	DB6	DB5	DB4	DB3	DB2	DB1	DB0			
Clear display	X	0	0	0	0	0	0	0	0	0	0	1	Write "20H" to DDRAM. and set DDRAM address to "00H" from AC.	1.53ms
Return home	0	0	0	0	0	0	0	0	0	0	1	X	Set DDRAM address to "00H" from AC and return cursor to its original position if shifted. The contents of DDRAM are not changed.	1.53ms
Power down mode	1	0	0	0	0	0	0	0	0	0	1	PD	Set power down mode bit. PD = "1" :power down mode set, PD = "0" :power down mode disable	39μs
Entry mode set	0	0	0	0	0	0	0	0	0	1	I/D	S	Assign cursor moving direction. I/D = "1": increment, I/D = "0": decrement and display shift enable bit. S = "1": make display shift of the enabled lines by the DS4 - DS1 bits in the shift enable instruction. S = "0": display shift disable	39μs
	1	0	0	0	0	0	0	0	0	1	1	BID	Segment bi-direction function. BID = "0": Seg1 → Seg80, BID = "1": Seg80 → Seg1.	
Display on/off control	0	0	0	0	0	0	0	0	1	D	C	B	Set display/cursor/blink on/off D = "1": display on, D = "0": display off, C = "1": cursor on, C = "0": cursor off, B = "1": blink on, B = "0": blink off.	39μs

Instruction Set 1 (Continued)

Instruction	RE	Instruction Code										Description	Execution Time (fosc = 270kHz)
		RS	R/W	DB7	DB6	DB5	DB4	DB3	DB2	DB1	DB0		
Extended function set	1	0	0	0	0	0	0	1	FW	B/W	NW	Assign font width, black/white inverting of cursor, and 4-line display mode control bit. FW = "1": 6-dot font width, FW = "0": 5-dot font width, B/W = "1": black/white inverting of cursor enable, B/W = "0": black/white inverting of cursor disable NW = "1" : 4-line display mode, NW = "0" : 1-line or 2-line display mode.	39μs
Cursor or display shift	0	0	0	0	0	0	1	S/C	R/L	X	X	Cursor or display shift. S/C = "1": display shift, S/C = "0": cursor shift, R/L = "1": shift to right, R/L = "0": shift to left.	39μs
Shift enable	1	0	0	0	0	0	1	DS4	DS3	DS2	DS1	(when DH = "1") Determine the line for display shift DS1 = "1/0": 1st line display shift enable/disable DS2 = "1/0": 2nd line display shift enable/disable DS3 = "1/0": 3rd line display shift enable/disable DS4 = "1/0": 4th line display shift enable/disable.	39μs
Scroll enable	1	0	0	0	0	0	1	HS4	HS3	HS2	HS1	(when DH = "0") Determine the line for horizontal smooth scroll. HS1 = "1/0": 1st line dot scroll enable/disable HS2 = "1/0": 2nd line dot scroll enable/disable HS3 = "1/0": 3rd line dot scroll enable/disable HS4 = "1/0": 4th line dot scroll enable/disable.	39μs

Instruction Set 1 (Continued)

Instruction	RE	Instruction Code										Description	Execution Time (fosc = 270kHz)
		RS	R/W	DB7	DB6	DB5	DB4	DB3	DB2	DB1	DB0		
Function Set	0	0	0	0	0	1	DL	N	RE (0)	DH	REV	Set interface data length (DL = "1": 8-bit, DL = "0": 4-bit), numbers of display line when NW = "0", (N = "1": 2-line, N = "0": 1-line), extension register, RE ("0"), shift/scroll enable DH = "1": display shift enable DH = "0": dot scroll enable. reverse bit REV = "1": reverse display, REV = "0": normal display.	39μs
	1	0	0	0	0	1	DL	N	RE (1)	BE	0	Set DL, N, RE ("1") and CGRAM/SEGRAM blink enable (BE) BE = "1/0": CGRAM/SEGRAM blink enable/disable	39μs
Set CGRAM address	0	0	0	0	1	AC5	AC4	AC3	AC2	AC1	AC0	Set CGRAM address in address counter.	39μs
Set SEGRAM address	1	0	0	0	1	X	X	AC3	AC2	AC1	AC0	Set SEGRAM address in address counter.	39μs
Set DDRAM address	0	0	0	1	AC6	AC5	AC4	AC3	AC2	AC1	AC0	Set DDRAM address in address counter.	39μs
Set scroll quantity	1	0	0	1	X	SQ 5	SQ 4	SQ 3	SQ 2	SQ 1	SQ 0	Set the quantity of horizontal dot scroll.	39μs
Read busy flag and address	X	0	1	BF	AC6	AC5	AC4	AC3	AC2	AC1	AC0	Can be known whether during internal operation or not by reading BF. The contents of address counter can also be read. BF = "1": busy state, BF = "0": ready state.	0μs
Write data	X	1	0	D7	D6	D5	D4	D3	D2	D1	D0	Write data into internal RAM (DDRAM / CGRAM / SEGRAM).	43μs
Read data	X	1	1	D7	D6	D5	D4	D3	D2	D1	D0	Read data from internal RAM (DDRAM / CGRAM / SEGRAM).	43μs

NOTES:

1. When an MPU program with busy flag (DB7) checking is mode, 1/2 fosc (is necessary) for executing the next instruction by the "E" signal after the busy flag (DB7) goes to "Low"
2. "X" don't care

7 Optical Characteristics

7.1 Optical Characteristics

Ta=25°C

Item	Symbol	Condition	Min.	Typ.	Max.	Unit	
Viewing Angle	θ_x	$C_r \geq 2$	$\theta_y = 0^\circ$	-20	--	30	Deg
	θ_y						
Contrast Ratio	C_r	$\theta_x = 0^\circ$ $\theta_y = 0^\circ$	3.0	-	-		
Response Time	Turn on	$\theta_x = 0^\circ$ $\theta_y = 0^\circ$	-	-	300	ms	
	Turn off		-	-	300		

7.2 Definition of Optical Characteristics

7.2.1 Definition of Viewing Angle

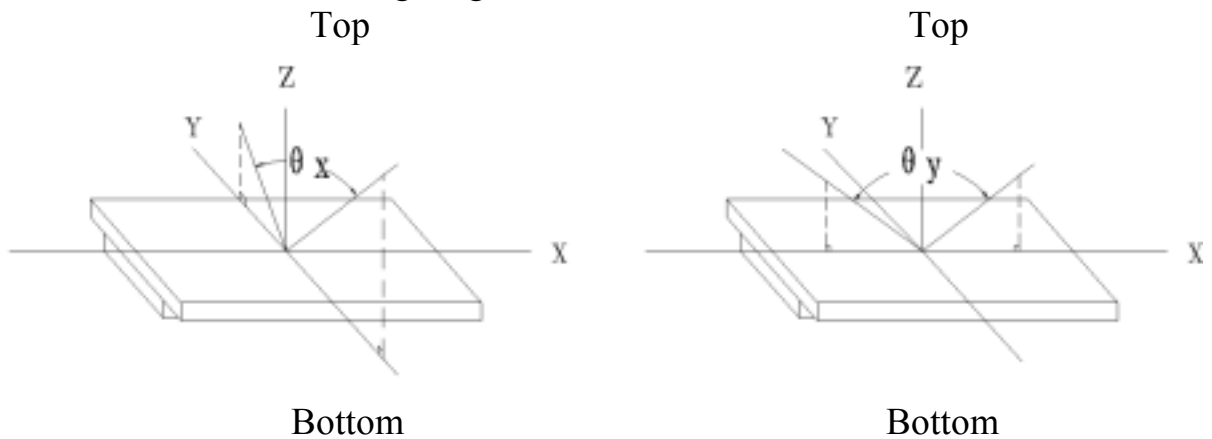

7.2.2 Definition of Contrast Ratio

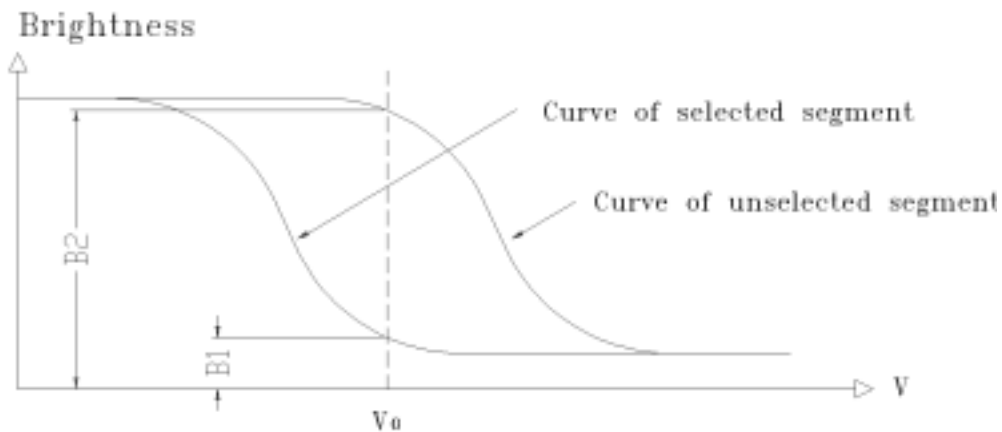

$$\text{Contrast Ratio} = B2/B1 = \frac{\text{unselected state brightness}}{\text{selected state brightness}}$$

Measuring Conditions:

- 1) Ambient Temperature: 25°C ;
- 2) Frame frequency: 68.2Hz

7.2.3 Definition of Response time

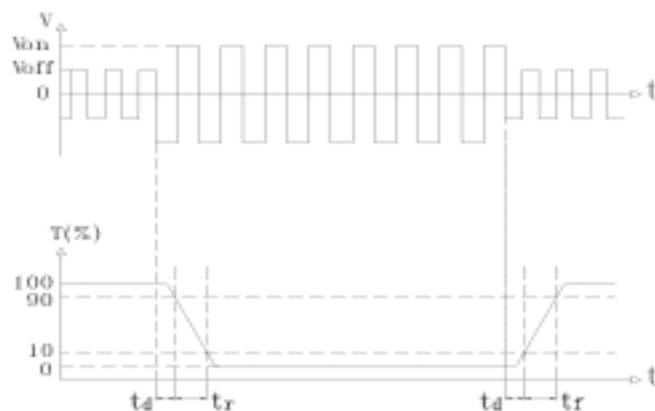

Turn on time: $t_{on} = t_d + t_r$ Turn off time: $t_{off} = t_d + t_r$

Measuring Condition:

- 1) Operating Voltage: 7.0V
- 2) Frame frequency: 68.2Hz

8 Reliability

8.1 Content of Reliability Test

Ta=25°C

No.	Test Item	Content of Test	Test condition
1	High Temperature Storage	Endurance test applying the high storage temperature for a long time	60°C 96H
2	Low Temperature Storage	Endurance test applying the low storage temperature for a long time	-20°C 96H
3	High Temperature Operation	Endurance test applying the electric stress (voltage & current) and the thermal stress to the element for a long time	50°C 96H
4	Low Temperature Operation	Endurance test applying the electric stress under low temperature for a long time	0°C 96H
5	High Temperature /Humidity Storage	Endurance test applying the high temperature and high humidity storage for a long time	40°C 90%RH 96H
6	Temperature Cycle	Endurance test applying the low and high temperature cycle $-20^{\circ}\text{C} \xleftrightarrow{30\text{min}} 25^{\circ}\text{C} \xleftrightarrow{5\text{min}} 60^{\circ}\text{C} \xleftrightarrow{30\text{min}} 25^{\circ}\text{C} \xleftrightarrow{5\text{min}} \rightarrow$ <p style="text-align: center;">← 1 cycle →</p>	-20°C/60°C 10 cycles
7	Vibration Test (package state)	Endurance test applying the vibration during transportation	10Hz~150Hz 50m/s ² 40min
8	Shock Test (package state)	Endurance test applying the shock during transportation	Half- sine wave 100m/s ² , 11ms
9	Atmospheric Pressure Test	Endurance test applying the atmospheric pressure during transportation by air	40kPa 16H

8.2 Failure Judgment Criterion

Criterion Item	Test Item No.									Failure Judgement Criterion
	1	2	3	4	5	6	7	8	9	
Basic Specification	√	√	√	√	√	√	√	√	√	Out of the basic Specification
Electrical specification	√	√	√	√	√					Out of the electrical specification
Mechanical Specification							√	√		Out of the mechanical specification
Optical Characteristic	√	√	√	√	√	√			√	Out of the optical specification
Note	For test item refer to 8.1									
Remark	Basic specification = Optical specification + Mechanical specification									

9 QUALITY LEVEL

Examination or Test	At $T_a=25^\circ\text{C}$ (unless otherwise stated)	Inspection				
		Min.	Max.	Unit	IL	AQL
External Visual Inspection	Under normal illumination and eyesight condition, the distance between eyes and LCD is 25cm.	See Appendix A			II	Major 1.0 Minor 2.5
Display Defects	Under normal illumination and eyesight condition, display on inspection.	See Appendix B			II	Major 1.0 Minor 2.5
<p>Note: Major defects: Open segment or common, Short, Serious damages, Leakage Miner defects: Others Sampling standard conforms to GB2828</p>						

10 Precautions for Use of LCD Modules

10.1 Handling Precautions

10.1.1 The display panel is made of glass. Do not subject it to a mechanical shock by dropping it from a high place, etc.

10.1.2 If the display panel is damaged and the liquid crystal substance inside it leaks out, be sure not to get any in your mouth, if the substance comes into contact with your skin or clothes, promptly wash it off using soap and water.

10.1.3 Do not apply excessive force to the display surface or the adjoining areas since this may cause the color tone to vary.

10.1.4 The polarizer covering the display surface of the LCD module is soft and easily scratched. Handle this polarizer carefully.

10.1.5 If the display surface is contaminated, breathe on the surface and gently wipe it with a soft dry cloth. If still not completely clear, moisten cloth with one of the following solvents:

- Isopropyl alcohol
- Ethyl alcohol

Solvents other than those mentioned above may damage the polarizer. Especially, do not use the following:

- Water
- Ketone
- Aromatic solvents

10.1.6 Do not attempt to disassemble the LCD Module.

10.1.7 If the logic circuit power is off, do not apply the input signals.

10.1.8 To prevent destruction of the elements by static electricity, be careful to maintain an optimum work environment.

- a. Be sure to ground the body when handling the LCD Modules.
- b. Tools required for assembly, such as soldering irons, must be properly ground.
- c. To reduce the amount of static electricity generated, do not conduct assembly and other work under dry conditions.
- d. The LCD Module is coated with a film to protect the display surface. Be care when peeling off this protective film since static electricity may be generated.

10.2 Storage precautions

10.2.1 When storing the LCD modules, avoid exposure to direct sunlight or to the light of fluorescent lamps.

10.2.2 The LCD modules should be stored under the storage temperature range.

If the LCD modules will be stored for a long time, the recommend condition is:

Temperature : $0^{\circ}\text{C} \sim 40^{\circ}\text{C}$

Relatively humidity: $\leq 80\%$

10.2.3 The LCD modules should be stored in the room without acid, alkali and harmful gas.

10.3 The LCD modules should be no falling and violent shocking during transportation, and also should avoid excessive press, water, damp and sunshine.

Appendix A

Inspection items and criteria for appearance defects

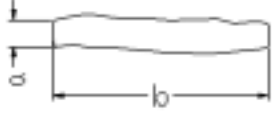
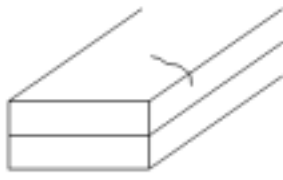
Items	Contents	Criteria		
Leakage		Not permitted		
Rainbow		According to the limit specimen		
Polarizer	Wrong polarizer attachment	Not permitted		
	Bubble between polarizer and glass	Not counted	Max. 3 defects allowed	
		$\phi < 0.3\text{mm}$	$0.3\text{mm} \leq \phi \leq 0.5\text{mm}$	
	Scratches of polarizer	According to the limit specimen		
Black spot (in viewing area)		Not counted	Max. 3 spots allowed	Max. 3 spots (lines) allowed
		$X < 0.2\text{mm}$	$0.2\text{mm} \leq X \leq 0.5\text{mm}$	
		$X = (a+b)/2$		
Black line (in viewing area)		Not counted	Max. 3 lines allowed	
		$a < 0.02\text{mm}$	$0.02\text{mm} \leq a \leq 0.05\text{mm}$ $b \leq 2.0\text{mm}$	
Progressive cracks		Not permitted		

Appendix B

Inspection items and criteria for display defects

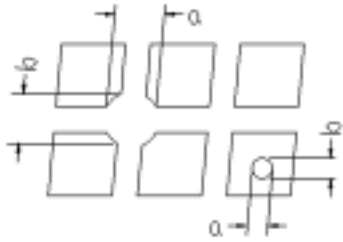
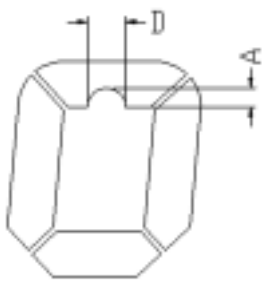
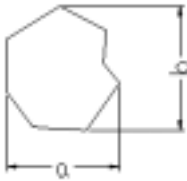
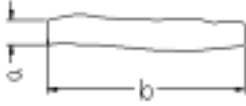
Items	Contents	Criteria			
Open segment or open common		Not permitted			
Short		Not permitted			
Wrong viewing angle		Not permitted			
Contrast ratio uneven		According to the limit specimen			
Crosstalk		According to the limit specimen			
Pin holes and cracks in segment (DOT)		Not counted	Max.3 dots allowed		Max.3 dots allowed
		$X < 0.1\text{mm}$	$0.1\text{mm} \leq X \leq 0.2\text{mm}$		
		$X = (a+b)/2$			
		Not counted	Max.2 dots allowed		
$A < 0.1\text{mm}$		$0.1\text{mm} \leq A \leq 0.2\text{mm}$ $D < 0.25\text{mm}$			
Black spot (in viewing area)		Not counted	Max.3 spots allowed		Max.3 spots (lines) allowed
		$X < 0.1\text{mm}$	$0.1\text{mm} \leq X \leq 0.2\text{mm}$		
		$X = (a+b)/2$			
Black line (in viewing area)		Not counted	Max.3 lines allowed		
		$a < 0.02\text{mm}$	$0.02\text{mm} \leq a \leq 0.05\text{mm}$ $b \leq 0.5\text{mm}$		

Appendix B

Inspection items and criteria for display defects (continued)

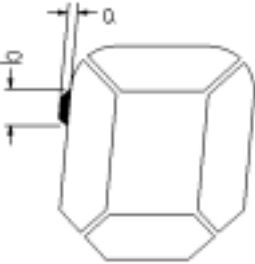
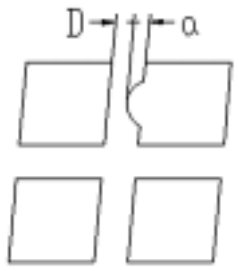
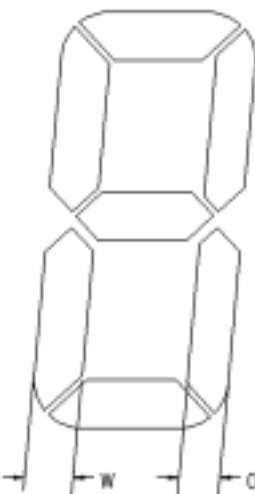
Items	Content	Criteria				
Transformation of segment		Not counted	Max. 2 defects allowed	Max.3 defects allowed		
		$x < 0.1\text{mm}$	$0.1\text{mm} \leq x \leq 0.2\text{mm}$			
		$x = (a+b)/2$				
		Not counted	Max. 1 defects allowed			
		$a < 0.1\text{mm}$	$0.1\text{mm} \leq a \leq 0.2\text{mm}$ $D > 0$			
		Max.2 defects allowed $0.8W \leq a \leq 1.2W$ $a = \text{measured value of width}$ $W = \text{nominal value of width}$				